

Uninterruptible power supply - TRIO-UPS/1AC/24DC/ 5



2866611

<https://www.phoenixcontact.com/in/products/2866611>

Please be informed that the data shown in this PDF document is generated from our Online Catalog. Please find the complete data in the user documentation. Our General Terms of Use for Downloads are valid.



Uninterruptible power supply with integrated power supply unit. For lead AGM energy storage of type MINI-BAT/24/DC/1.3 AH, QUINT-BAT/24DC 3.4 AH ... 12 AH nominal capacity. Input: 1-phase, output: 24 V DC / 5 A. Screw connection technology

Product Description

The TRIO UPS module with integrated power supply is particularly space-saving: UPS module and power supply in one housing. Only one energy storage is required to complete the UPS system.

Energy storage with lead AGM technology buffers failures lasting up to two hours with 5 A load current.

Your advantages

- Autonomous – in the event of AC mains failure the industrial PC continues operating without interruption
- Time-saving – when the supply voltage is restored, the industrial PC starts automatically

Uninterruptible power supply - TRIO-UPS/1AC/24DC/ 5



2866611

<https://www.phoenixcontact.com/in/products/2866611>

Commercial Data

Item number	2866611
Packing unit	1 pc
Minimum order quantity	1 pc
Sales Key	CMU
Product Key	CMUT13
Catalog Page	Page 300 (C-4-2017)
GTIN	4046356311809
Weight per Piece (including packing)	1,117 g
Weight per Piece (excluding packing)	1,100 g
Customs tariff number	85044030
Country of origin	CN

Technical Data

Input data

DC operation

Input voltage	24 V DC
Nominal input voltage range	100 V AC ... 240 V AC
Input voltage range	85 V AC ... 264 V AC (Derating < 90 V AC: 2.5%V) 100 V DC ... 350 V DC (UL508: 100 ... 250 V)
Input voltage range AC	85 V AC ... 264 V AC (Derating < 90 V AC: 2.5%V)
Input voltage range DC	100 V DC ... 350 V DC (UL508: 100 ... 250 V)
Voltage type of supply voltage	AC/DC
Inrush current	< 44 A (< 1.3 A ² s)
Inrush current integral (I ² t)	< 1.3 A ² s
AC frequency range	45 Hz ... 65 Hz
Frequency range DC	0 Hz
Mains buffering time	see diagram
Buffer period	20 min. (5 A)
Rotary selector switch	adjustable: 0.5 min; 1 min; 2 min; 3 min; 5 min; 10 min; 15 min; 20 min; PC-Mode
Current consumption	0.95 A (230 V AC) 1.1 A (230 V AC, maximum) 1.7 A (120 V AC) 1.8 A (120 V AC, maximum)
Protective circuit	Transient surge protection; Varistor
Power factor (cos phi)	approx. 0.5
Typical response time	150 ms (230 V AC) 200 ms (120 V AC)
Input fuse	6.3 A (slow-blow, internal)
Permissible backup fuse	B6 B10 B16
Recommended breaker for input protection	6 A ... 16 A (Characteristics B, C, D, K)

Output data

Efficiency	> 88 % (230 V AC, network operation) > 86 % (120 V AC, network operation) > 86 % (Battery operation)
Nominal output voltage	24 V DC
Setting range of the output voltage (U _{Set})	22.5 V DC ... 29.5 V DC (Network operation; in the buffer mode, dependent on the battery voltage of 27.9 V DC ... 19.2 V DC)
Nominal output current (I _N)	5 A (-25 °C ... 55 °C)
Output current limit	max. 6 A (Mains operation)
Bridging time	3600 s
Derating	55 °C ... 70 °C (2.5%/K)
Feedback voltage resistance	35 V DC

Uninterruptible power supply - TRIO-UPS/1AC/24DC/ 5



2866611

<https://www.phoenixcontact.com/in/products/2866611>

Protection against overvoltage at the output (OVP)	< 35 V DC
Control deviation	< 1 % (change in load, static 10 % ... 90 %)
Residual ripple	< 10 mV _{PP}
Output power	120 W
Peak switching voltages nominal load	< 25 mV _{PP}
Power dissipation	16 W (230 V AC)
	20 W (120 V AC)
	2 W (Maximum, no load)
	4 W (Maximum, nominal load)
Rise time	< 100 ms
Connection in parallel	yes, 2
Connection in series	No

Mains operation

Nominal output voltage	24 V DC
Output voltage range	22.5 V DC ... 29.5 V DC
Nominal output current (I _N)	5 A

Battery operation

Nominal output voltage	24 V DC
Output voltage range	19.2 V DC ... 27.6 V DC (U _{OUT} = U _{BAT} - 0,5 V DC)
Nominal output current (I _N)	5 A

Signal

Output voltage	+ 24 V
----------------	--------

Signal: Alarm

Output description	Transistor switching output
Maximum switching voltage	≤ 24 V
Output voltage	24 V
Continuous load current	≤ 200 mA

Signal: Battery charge

Output description	Transistor switching output
Maximum switching voltage	≤ 24 V
Output voltage	24 V
Continuous load current	≤ 200 mA

Signal: Battery mode

Output description	Transistor switching output
Maximum switching voltage	≤ 24 V
Output voltage	24 V
Continuous load current	≤ 200 mA

Signal

Output voltage	+ 24 V
----------------	--------

Signal: Alarm

Uninterruptible power supply - TRIO-UPS/1AC/24DC/ 5



2866611

<https://www.phoenixcontact.com/in/products/2866611>

Output description	Transistor switching output
Maximum switching voltage	≤ 24 V
Output voltage	24 V
Continuous load current	≤ 200 mA

Signal: Battery charge

Output description	Transistor switching output
Maximum switching voltage	≤ 24 V
Output voltage	24 V
Continuous load current	≤ 200 mA

Signal: Battery mode

Output description	Transistor switching output
Maximum switching voltage	≤ 24 V
Output voltage	24 V
Continuous load current	≤ 200 mA

Signal

Output voltage	+ 24 V
----------------	--------

Signal: Alarm

Output description	Transistor switching output
Maximum switching voltage	≤ 24 V
Output voltage	24 V
Continuous load current	≤ 200 mA

Signal: Battery charge

Output description	Transistor switching output
Maximum switching voltage	≤ 24 V
Output voltage	24 V
Continuous load current	≤ 200 mA

Signal: Battery mode

Output description	Transistor switching output
Maximum switching voltage	≤ 24 V
Output voltage	24 V
Continuous load current	≤ 200 mA

Signal

Output voltage	+ 24 V
----------------	--------

Signal: Alarm

Output description	Transistor switching output
Maximum switching voltage	≤ 24 V
Output voltage	24 V
Continuous load current	≤ 200 mA

Signal: Battery charge

2866611

<https://www.phoenixcontact.com/in/products/2866611>

Output description	Transistor switching output
Maximum switching voltage	≤ 24 V
Output voltage	24 V
Continuous load current	≤ 200 mA

Signal: Battery mode

Output description	Transistor switching output
Maximum switching voltage	≤ 24 V
Output voltage	24 V
Continuous load current	≤ 200 mA

Energy storage

End-of-charge voltage	25 V DC ... 30 V DC (Default 27.6 V DC)
Charge current	1.5 A
Deep discharge protection	18 V DC ... 21 V DC (Default 19.2 V DC)
Memory medium	external, battery 1.3 Ah / 3.4 Ah / 7.2 Ah / 12 Ah
Battery presence check/time interval	60 s
Quality check of battery	4 h ... 200 h (Default 12 h)
Charge characteristic curve	I/U characteristic curve
IQ technology	no
Temperature compensation	0 mV/K ... 200 mV/K (42 mV/K by default)
Alarm signaling threshold	18 V DC ... 30 V DC (Default 20.4 V DC)
Network management	No

Connection data

Input

Connection method	Screw connection
Conductor cross section solid min.	0.2 mm ²
Conductor cross section solid max.	2.5 mm ²
Conductor cross section flexible min.	0.2 mm ²
Conductor cross section flexible max.	2.5 mm ²
Conductor cross section AWG min.	24
Conductor cross section AWG max.	12
Screw thread	M3
Tightening torque, min	0.5 Nm
Tightening torque max	0.6 Nm

Output

Connection method	Screw connection
Conductor cross section solid min.	0.2 mm ²
Conductor cross section solid max.	2.5 mm ²
Conductor cross section flexible min.	0.2 mm ²
Conductor cross section flexible max.	2.5 mm ²
Conductor cross section AWG min.	24
Conductor cross section AWG max.	12

Uninterruptible power supply - TRIO-UPS/1AC/24DC/ 5



2866611

<https://www.phoenixcontact.com/in/products/2866611>

Stripping length	8 mm
Screw thread	M3
Tightening torque, min	0.5 Nm
Tightening torque max	0.6 Nm

Signal

Conductor cross section solid min.	0.2 mm ²
Conductor cross section solid max.	2.5 mm ²
Conductor cross section flexible min.	0.2 mm ²
Conductor cross section flexible max.	2.5 mm ²
Conductor cross section AWG min.	24
Conductor cross section AWG max.	12
Screw thread	M3
Tightening torque, min	0.5 Nm
Tightening torque max	0.6 Nm

Interfaces

Interface	IFS (Interface system data port)
-----------	----------------------------------

LED signaling

Types of signaling	LED
--------------------	-----

Signal output

Status display	Green LED
Note on status display	Mains voltage OK: Green LED, static at

Signal output: Alarm

Status display	Alarm
Note on status display	Red LED, static at

Signal output: Battery charge

Status display	Battery (battery charge) is being charged
Note on status display	Yellow LED, flashing

Signal output: Battery mode

Status display	Battery operation (Battery Mode)
Note on status display	LED yellow, static at

Electrical properties

Insulation voltage input/output	4 kV (type test)
	2 kV (routine test)
Insulation voltage output / PE	500 V DC (routine test)
Insulation voltage input / PE	2 kV AC (type test)
	2 kV AC (routine test)

Product properties

Product type	Uninterruptible power supply
--------------	------------------------------

Uninterruptible power supply - TRIO-UPS/1AC/24DC/ 5



2866611

<https://www.phoenixcontact.com/in/products/2866611>

IQ technology	no
MTBF (IEC 61709, SN 29500)	> 596000 h (40 °C)

Insulation characteristics

Protection class	I
Degree of pollution	2

Dimensions

Width	60 mm
Height	130 mm
Depth	118 mm

Installation dimensions

Installation distance right/left	0 mm / 0 mm
Installation distance top/bottom	50 mm / 50 mm

Mounting

Mounting type	DIN rail mounting
Assembly instructions	alignable: horizontally 0 mm, vertically 50 mm
Mounting position	horizontal DIN rail NS 35, EN 60715

Material specifications

Color	aluminium
Type of housing	Aluminum (AlMg3) + zinc-plated sheet steel, enclosed
Housing material	Aluminum (AlMg3) / sheet steel, zinc-plated

Environmental and real-life conditions

Ambient conditions

Degree of protection	IP20
Ambient temperature (operation)	-25 °C ... 70 °C (> 55° C derating : 2.5%/K)
Ambient temperature (storage/transport)	-40 °C ... 80 °C
Climatic class	3K3 (in acc. with EN 60721)
Max. permissible relative humidity (operation)	95 % (at 25 °C, non-condensing)
Shock	18 ms, 30g, in each space direction (according to IEC 60068-2-27)
Vibration (operation)	< 15 Hz, amplitude ±2.5 mm (according to IEC 60068-2-6) 15 Hz ... 150 Hz, 2.3g, 90 min.

Standards and regulations

Rail applications	EN 50121-4
Standard – Electronic equipment for use in electrical power installations and their assembly into electrical power installations	EN 50178/VDE 0160 (PELV)
Standard – Limitation of mains harmonic currents	EN 61000-3-2
Standard - Electrical safety	EN 60950-1/VDE 0805 (SELV)
Standard – Protection against shock currents, basic requirements for protective separation in electrical equipment	EN 50178

Uninterruptible power supply - TRIO-UPS/1AC/24DC/ 5



2866611

<https://www.phoenixcontact.com/in/products/2866611>

Standard – Safety extra-low voltage	EN 60950-1 (SELV)
	EN 60204 (PELV)
Standard - Safe isolation	DIN VDE 0100-410

Approval data

Shipbuilding approval	DNV GL (EMC B)
UL approvals	UL/C-UL listed UL 508
	UL/C-UL Recognized UL 60950-1

EMC data

Low Voltage Directive	Conformance with Low Voltage Directive 2014/35/EC
Electromagnetic compatibility	Conformance with EMC Directive 2014/30/EU
EMC requirements for noise emission	EN 61000-6-3
	EN 61000-6-4
EMC requirements for noise immunity	EN 61000-6-1
	EN 61000-6-2
Noise emission	EN 55011 (EN 55022)
Noise immunity	EN 61000-6-2:2005

Electrostatic discharge

Standards/regulations	EN 61000-4-2
Housing	Level 3

Electrostatic discharge

Contact discharge	6 kV
Discharge in air	8 kV
Comments	Criterion B

Electromagnetic HF field

Standards/regulations	EN 61000-4-3
-----------------------	--------------

Electromagnetic HF field

Frequency range	80 MHz ... 2 GHz
Test field strength	10 V/m
Comments	Criterion A

Fast transients (burst)

Standards/regulations	EN 61000-4-4
-----------------------	--------------

Fast transients (burst)

Input	4 kV (level 4 - asymmetrical: conductor to ground)
Output	2 kV (level 4 - asymmetrical: conductor to ground)
Signal	1 kV (level 4 - asymmetrical: conductor to ground)
Comments	Criterion B

Surge voltage load (surge)

Standards/regulations	EN 61000-4-5
-----------------------	--------------

Uninterruptible power supply - TRIO-UPS/1AC/24DC/ 5



2866611

<https://www.phoenixcontact.com/in/products/2866611>

Conducted interference

Standards/regulations	EN 61000-4-6
-----------------------	--------------

Conducted interference

I/O/S	Level 3
Frequency range	10 kHz ... 80 MHz
Comments	Criterion A
Voltage	10 V

Voltage dips

Standards/regulations	EN 61000-4-11
-----------------------	---------------

Emitted interference

Standards/regulations	EN 61000-6-3
Radio interference voltage in acc. with EN 55011	EN 55011 (EN 55022) Class B, area of application: Industry and residential
Emitted radio interference in acc. with EN 55011	EN 55011 (EN 55022) Class B, area of application: Industry and residential

Drawings

Diagram

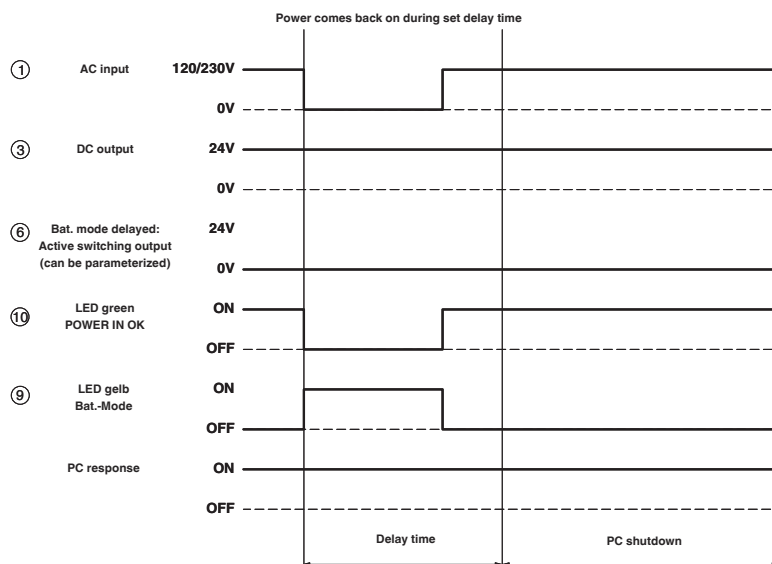

Diagram

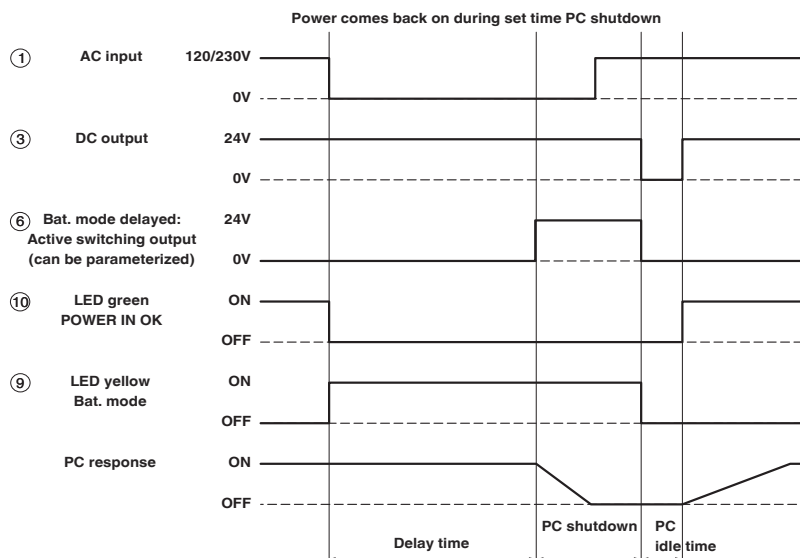

Block diagram

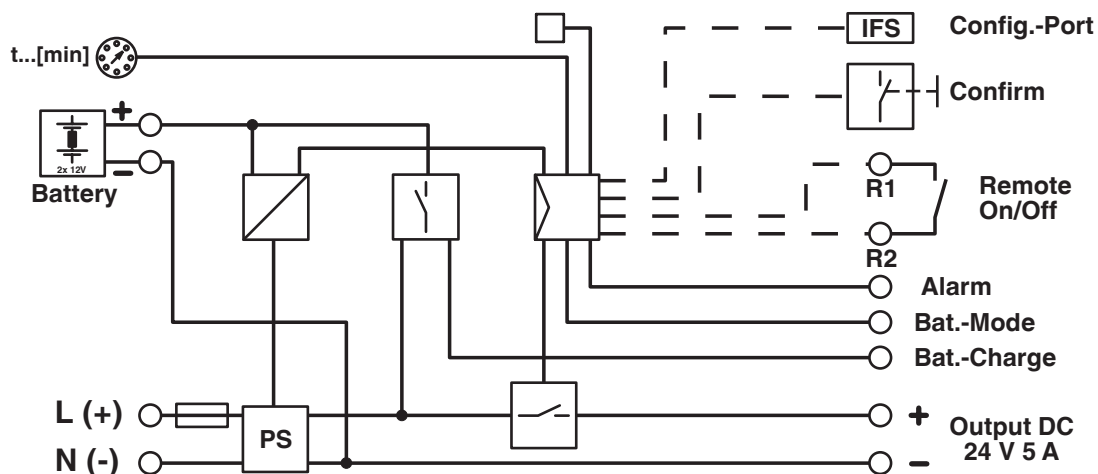

Diagram

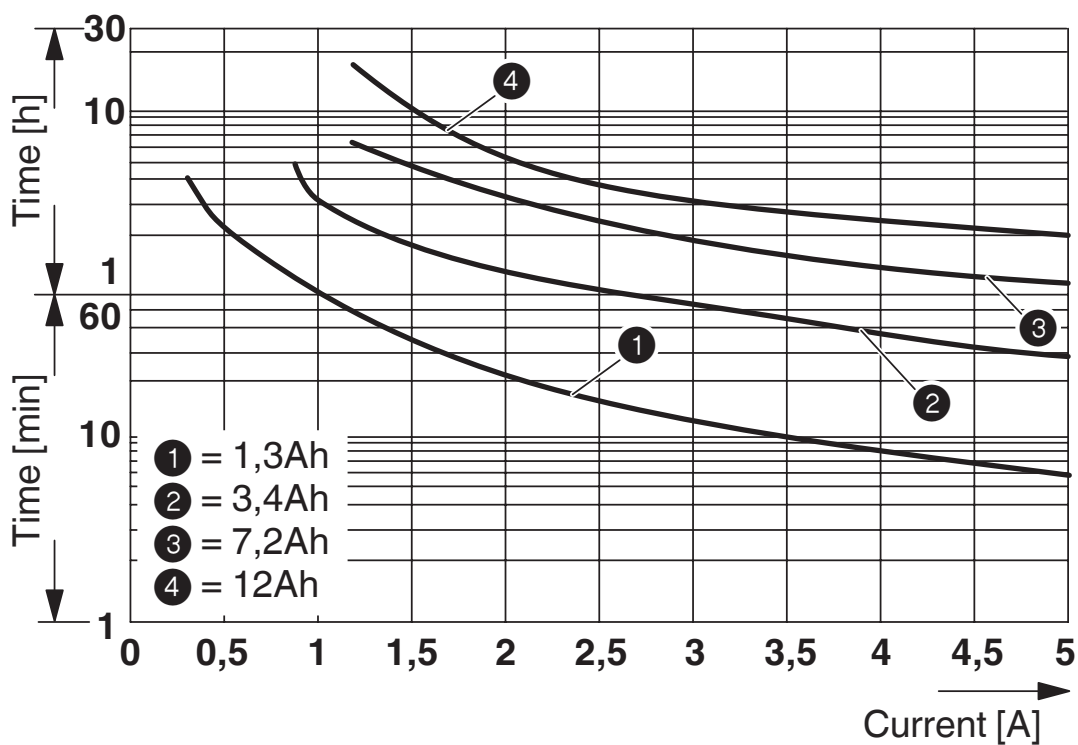

Uninterruptible power supply - TRIO-UPS/1AC/24DC/ 5



2866611

<https://www.phoenixcontact.com/in/products/2866611>

Approvals

 UL Recognized

 cUL Recognized

 cUL Listed

 UL Listed

 EAC

 EAC

 EAC

 cUL Recognized

 UL Recognized

 EAC

 EAC

 UL Listed

 cUL Listed

Uninterruptible power supply - TRIO-UPS/1AC/24DC/ 5



2866611

<https://www.phoenixcontact.com/in/products/2866611>

ERC EAC

Uninterruptible power supply - TRIO-UPS/1AC/24DC/ 5



2866611

<https://www.phoenixcontact.com/in/products/2866611>

Classifications

ECLASS

ECLASS-9.0	27040705
ECLASS-10.0.1	27040705
ECLASS-11.0	27040705

ETIM

ETIM 8.0	EC000382
----------	----------

UNSPSC

UNSPSC 21.0	39121011
-------------	----------

Uninterruptible power supply - TRIO-UPS/1AC/24DC/ 5



2866611

<https://www.phoenixcontact.com/in/products/2866611>

Environmental Product Compliance

REACH SVHC	Lead 7439-92-1
China RoHS	Environmentally Friendly Use Period = 25; For details about hazardous substances go to tab "Downloads", Category "Manufacturer's declaration"

2866611

<https://www.phoenixcontact.com/in/products/2866611>

Accessories

DIN rail adapter

DIN rail adapter - UTA 107 - 2853983

<https://www.phoenixcontact.com/in/products/2853983>

Universal DIN rail adapter, for screwing on switchgear



Fuse

Fuse - SI FORM C 15 A DIN 72581 - 0913676

<https://www.phoenixcontact.com/in/products/0913676>

Flat-type plug-in fuse, type C, color code: light blue, nominal current: 15 A



2866611

<https://www.phoenixcontact.com/in/products/2866611>

Fuse

Fuse - SI FORM C 25 A DIN 72581 - 0913757

<https://www.phoenixcontact.com/in/products/0913757>



Flat-type plug-in fuse, type C, color code: white, nominal current: 25 A

Data cable

Data cable - IFS-USB-DATACABLE - 2320500

<https://www.phoenixcontact.com/in/products/2320500>



Used for communicating between industrial PCs and Phoenix Contact devices with the 12-pos. IFS data port, such as QUINT UPS or TRIO UPS.

Uninterruptible power supply - TRIO-UPS/1AC/24DC/ 5



2866611

<https://www.phoenixcontact.com/in/products/2866611>

Programming adapter

Programming adapter - IFS-USB-PROG-ADAPTER - 2811271

<https://www.phoenixcontact.com/in/products/2811271>



Programming adapter with USB interface, for programming with software. The USB driver is included in the software solutions for the products to be programmed, such as measuring transducers or motor managers.

Mounting adapter

Mounting adapter - QUINT-PS-ADAPTERS7/2 - 2938206

<https://www.phoenixcontact.com/in/products/2938206>

Assembly adapter for QUINT POWER 10A on S7-300 rail



2866611

<https://www.phoenixcontact.com/in/products/2866611>

Mounting adapter

Mounting adapter - UWA 182/52 - 2938235

<https://www.phoenixcontact.com/in/products/2938235>



Universal wall adapter for securely mounting the device in the event of strong vibrations. The device is screwed directly onto the mounting surface. The universal wall adapter is attached on the top/bottom.

Memory block

Memory block - IFS-CONFSTICK-L - 2901103

<https://www.phoenixcontact.com/in/products/2901103>



Multi-functional memory block with handle for the INTERFACE system; for easy storage and back up of the configuration.

2866611

<https://www.phoenixcontact.com/in/products/2866611>

Memory block

Memory block - IFS-CONFSTICK - 2986122

<https://www.phoenixcontact.com/in/products/2986122>



Multi-functional memory block for the INTERFACE system for easy storage and backup of the configuration.

Energy storage

Energy storage - MINI-BAT/24DC/1.3AH - 2866417

<https://www.phoenixcontact.com/in/products/2866417>



Energy storage device, lead AGM, VRLA technology, 24 V DC, 1.2 Ah.

2866611

<https://www.phoenixcontact.com/in/products/2866611>

Energy storage

Energy storage - QUINT-BAT/24DC/ 3.4AH - 2866349

<https://www.phoenixcontact.com/in/products/2866349>



Energy storage device, lead AGM, VRLA technology, 24 V DC, 4 Ah. Connection via pin cable lug.

Energy storage

Energy storage - QUINT-BAT/24DC/ 7.2AH - 2866352

<https://www.phoenixcontact.com/in/products/2866352>



Energy storage device, lead AGM, VRLA technology, 24 V DC, 7.2 Ah. Connection via pin cable lug, 14 mm.

2866611

<https://www.phoenixcontact.com/in/products/2866611>

Energy storage

Energy storage - QUINT-BAT/24DC/12AH - 2866365

<https://www.phoenixcontact.com/in/products/2866365>



Energy storage device, lead AGM, VRLA technology, 24 V DC, 12 Ah.
Connection via pin cable lug, 14 mm.

Energy storage

Energy storage - UPS-BAT/VRLA/24DC/1.3AH - 2320296

<https://www.phoenixcontact.com/in/products/2320296>



Energy storage device, lead AGM, VRLA technology, 24 V DC, 1.3 Ah, tool-free battery replacement, automatic detection, and communication with QUINT UPS-IQ

2866611

<https://www.phoenixcontact.com/in/products/2866611>

Energy storage

Energy storage - UPS-BAT/VRLA/24DC/3.4AH - 2320306

<https://www.phoenixcontact.com/in/products/2320306>



Energy storage device, lead AGM, VRLA technology, 24 V DC, 3.4 Ah, tool-free battery replacement, automatic detection, and communication with QUINT UPS-IQ

Energy storage

Energy storage - UPS-BAT/VRLA/24DC/7.2AH - 2320319

<https://www.phoenixcontact.com/in/products/2320319>



Energy storage device, lead AGM, VRLA technology, 24 V DC, 7.2 Ah, tool-free battery replacement, automatic detection, and communication with QUINT UPS-IQ

Uninterruptible power supply - TRIO-UPS/1AC/24DC/ 5



2866611

<https://www.phoenixcontact.com/in/products/2866611>

Energy storage

Energy storage - UPS-BAT/VRLA/24DC/12AH - 2320322

<https://www.phoenixcontact.com/in/products/2320322>



Please use the following item in new systems: 1274119.

Energy storage device, lead AGM, VRLA technology, 24 V DC, 12 Ah, tool-free battery replacement, automatic detection, and communication with QUINT UPS-IQ

Phoenix Contact 2022 © - all rights reserved

<https://www.phoenixcontact.com>

PHOENIX CONTACT (I) Pvt. Ltd.

A-58/2, Okhla Industrial Area, Phase - II, New Delhi-110 020

+91.1275.71420

info@phoenixcontact.co.in